

LogTag[®]

TIC20

20 Day Transit Temperature Indicator
with display



DOCUMENT REVISION 1.3, 16 Apr 2013

© Copyright 2013, LogTag Recorders Limited

Contents

Contents 2

Document revision history 2

Introduction 3

Controls 3

Display Overview 4

 Display elements during monitoring 4

 Display elements when reviewing statistics 5

Operation 5

 Starting the Indicator 6

 Monitoring Display Mode 7

 Stopping the Indicator 8

 Battery indication 9

Alarm settings 10

 Sample Alarm settings 10

Reviewing Statistic Data 11

 Sample data set 11

 Review walk-through 12

TIC20 Factory Pre-sets 16

Product Specifications 17

Document revision history

Ver	Date	Author	Details
0.1		CW	Initial TIC10 10day device
0.2	3/8/2011	MJ	Mod to TIC20, 20 day device. Updated LCD images and added the four WHO types
0.3	7/12/2011	MJ	Updated LCD images to include triggered ALARM temperature points during MONITORING and STOPPED modes.
0.4	13/1/2012	MJ	Change entering Review mode to push and release within 1 second.
1.0	1/6/2012	MJ	Removed Type3 and Type4 Models, devices configured for 10 day only, 1 st released specification.
1.0	26/9/2012	MJ	Devices configured for 20days.
	17/10/12	MJ	Change memory type in product Specifications, corrected product weight.
1.1	13/12/12	SL	Corrected various issues, general edit for readability. Added correct photos
1.2	27/12/12	SL	Small adjustments in terminology to align with TICT specification document. Moved Specification to last page (same as TICT document).
1.3	16/04/13	SL	Created LogTag® specific version of document without WHO products, clarified temperature specs

Introduction

The LogTag® TIC20 20 Day Transit Pharmaceutical Temperature Indicator has been designed for use in applications where temperature & time statistics are monitored in pharmaceutical transports of up to 20 days duration.



The Indicator allows viewing key transit data on its built-in display, including statistics of readings that meet or exceed pre-specified alarm limits. This allows a shipment pass/fail decision to be made without the need for any other device such as a computer or printer. The display can be photocopied if a record is required. The indicator can be downloaded if required via the free LogTag Analyzer companion software and the TICT/TIC20 interface.



Two push buttons allow starting and stopping the Indicator and can also be used to navigate the various display screens.

Controls

The TIC20 has two buttons, which allow starting and stopping the Indicator and can also be used to navigate the various display screens.

	START STOP	Press and hold for 5 seconds to activate and START the Indicator. Press and hold for 6 seconds to STOP the Indicator. Return to Stopped screen during review
	REVIEW	Press and release within 1 second to view daily statistics. (when Indicator is stopped) Momentary press to advance the display to the next day's statistics.

While in **READY** or **STOPPED** mode the display will turn off to conserve power. Pressing either button will cause the screen to activate and remain activated for a period of 30 seconds of no button activity.

Display Overview

None of the alarm summary or statistic display modes have any flashing elements, so the display can be photocopied.

Display elements during monitoring

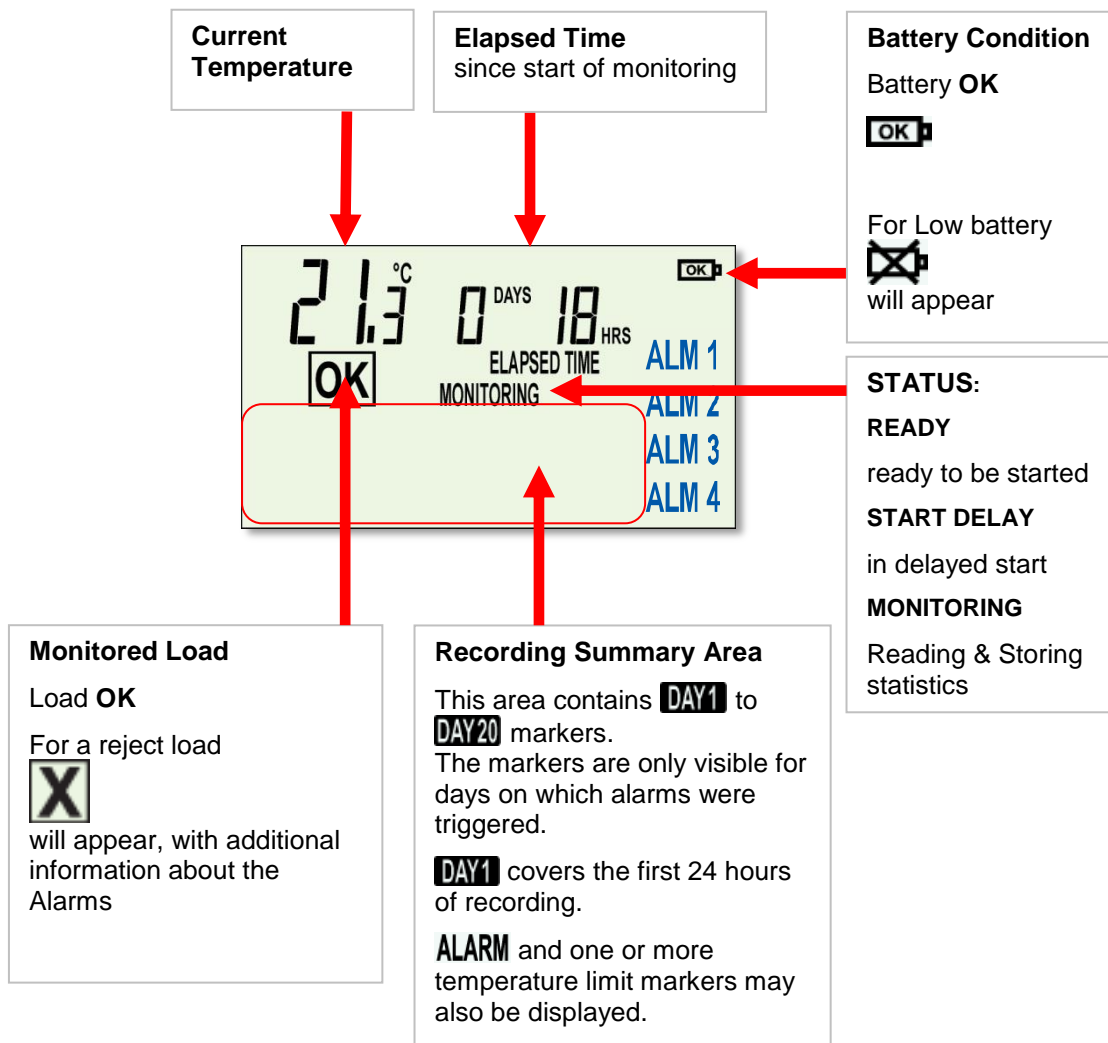

Display elements when reviewing statistics

Day's temperature summary

For each 24 hour period the maximum (**MAX**) or minimum (**MIN**) recorded temperature is shown, if it exceeded or fell below one of the pre-set alarm limits.

Day's time summary

If the recorded temperature exceeded or fell below one of the pre-set limits, the **DURATION** indicates how long the recorded values were above or below this limit (represented by the highlighted limit marker).

If this resulted in an Alarm being triggered, the **TRIGGER AT** time indicates the hour at which the temperature was first recorded above or below this limit.

STATUS:

STOPPED

Finished recording

Only when the indicator has been stopped can the statistics be displayed.

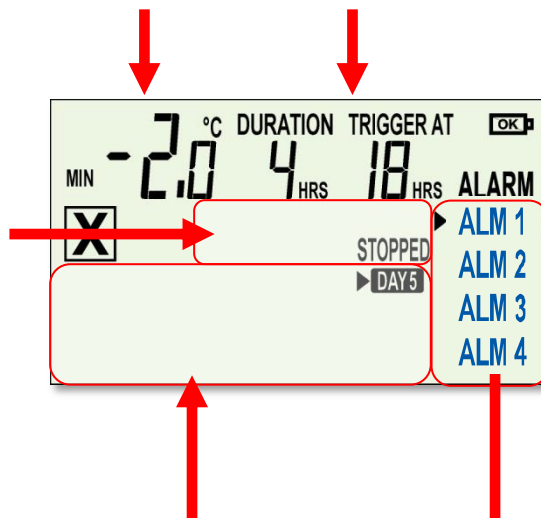

Recording summary

This area contains **DAY1** to **DAY20** markers.

The ► arrow next to a marker indicates the day for which the summary data are displayed.

DAY1 covers the first 24 hours of recording.

Limit Markers

For each day, statistics for up to four different temperature limits are collected.

If an arrow ► is displayed next to **ALM1**, **ALM2**, **ALM3** or **ALM4**, an alarm occurred at this level.

When reviewing, the arrow next to a temperature limit marker indicates this limit's statistics are being displayed.

Operation

Starting the Indicator





READY State

A short press of either button will activate the display.

If **READY** is displayed, the Indicator can be started.

The Battery condition is also displayed as

- OK 
- Low 

After 30 seconds the Indicator will re-enter a hibernated state and the display will switch off.



To start the Indicator press and hold the START button for 5 seconds.



The **MONITORING** indicator will flash.

When **MONITORING** is permanently lit, release the START button within 2 seconds.



START DELAY State

The indicator has now started its 60 minute **START DELAY** countdown. It should be immediately placed in the load to be monitored so that the temperature is stable and within specification once the monitoring begins.

Monitoring Display Mode

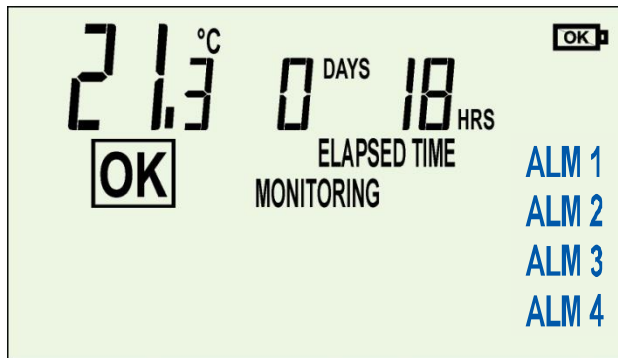

Monitoring Display - LOAD OK

In this example, the device has been monitoring for 18 hours and is still active.

The **OK** symbol is shown as no alarms have been triggered.

The last temperature reading is also displayed.

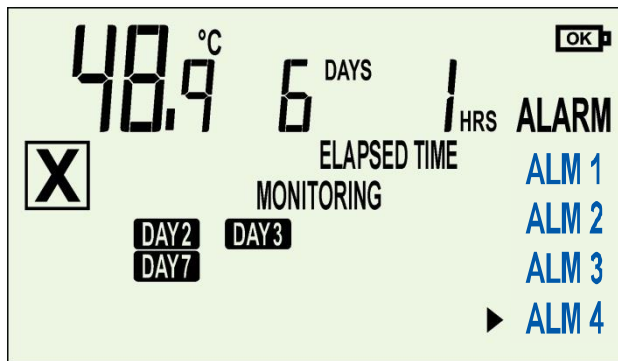

Monitoring Display - LOAD REJECT

In this example, the device has been monitoring for 6 days and 1 hour and is still active.

The **OK** symbol has been replaced by the **X** symbol, and since a >45°C ALARM has occurred, the load should be rejected.

Markers for the days on which the temperature has exceeded or fallen below the preset temperature limits are shown. The screen example shows that on **DAY2**, **DAY3** and **DAY7** temperatures outside the preset acceptance limits were recorded.

Both screens show 'MONITORING' to indicate that temperatures are still being recorded and that the unit is still active.

Stopping the Indicator

You must take care when stopping the indicator, as it cannot be restarted once stopped.



Stopping Display – initiating stop

Press and hold the STOP button for 6 seconds.



The text adjacent to the **MONITORING** text will flash, indicating a pending stop.

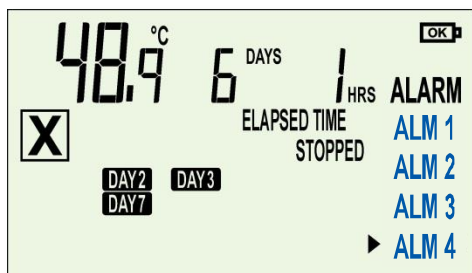

Stopping Display – pending stop waiting for release

When **STOPPED** is permanently lit, release the STOP button within 2 seconds.



If you release the STOP button before the **STOPPED** text becomes permanently lit, or you do not release the STOP button inside 2 seconds after the **STOPPED** text is permanently lit, the unit will not stop, and the state returns to **MONITORING**.

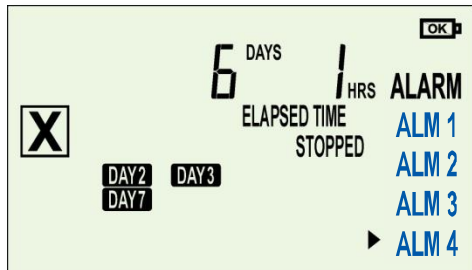

Stopped Display – Monitoring is complete

The indicator has now stopped recording.

The trip duration was 6 days and 1 hour.

An **ALARM** occurred on **DAY2**, **DAY3** and **DAY7**.

The load should be rejected as indicated by the **X** symbol.

Battery indication

The battery condition can be OK or LOW, as shown in the display examples below.

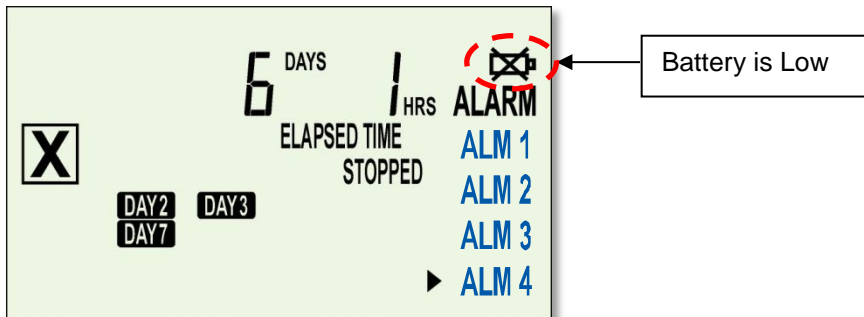
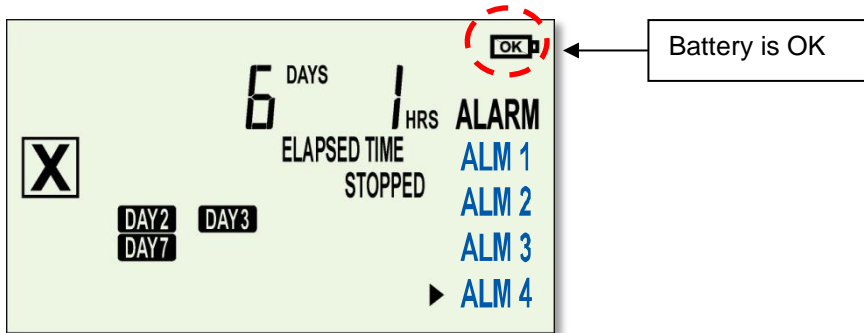

An Indicator should not be used if it shows the low battery symbol at the beginning of a trip. Indicators with a low battery not yet recording cannot be started.

Alarm settings

LogTag® TIC20 indicators are purchased with one of a number of different factory configuration profiles pre-installed (see TIC20 Factory Pre-sets on page 16). The following pages are based on these sample Alarm settings.

Alarm levels	Temperature alarm limit	Period of exposure
ALM1	<= -0.5°C single event	1 hour
ALM2	>= 30°C cumulative exposure	10 hours
ALM3	>= 45°C single event	1 hour
ALM4	Disabled	



Example of an alarm display for above alarm limits.

The **X** symbol is displayed continuously if any alarm was triggered during monitoring.

Temperature statistics for day 5 are displayed (cursor ► next to **DAY 5**).

The temperature went below the <-0.5°C limit (► next to **ALM 1**), which also triggered the 'ALARM'. The duration of the alarm and the trigger hour are also displayed.

Each day represents a period of 24 hours from 0:00:00 to 23:59:59. Day 1 begins when the start delay has elapsed and the Indicator starts monitoring. A new day starts when the clock advances from 23:59:59 to 0:00:00. On the display the 'hours' will change from 23 to 0.

Readings and durations are always allocated against the day in which they occur. If a new day starts during a period of exposure to temperatures outside the acceptable range, each day is allocated the partial time of exposure. Both parts count towards a single event.

Reviewing Statistic Data

Sample data set



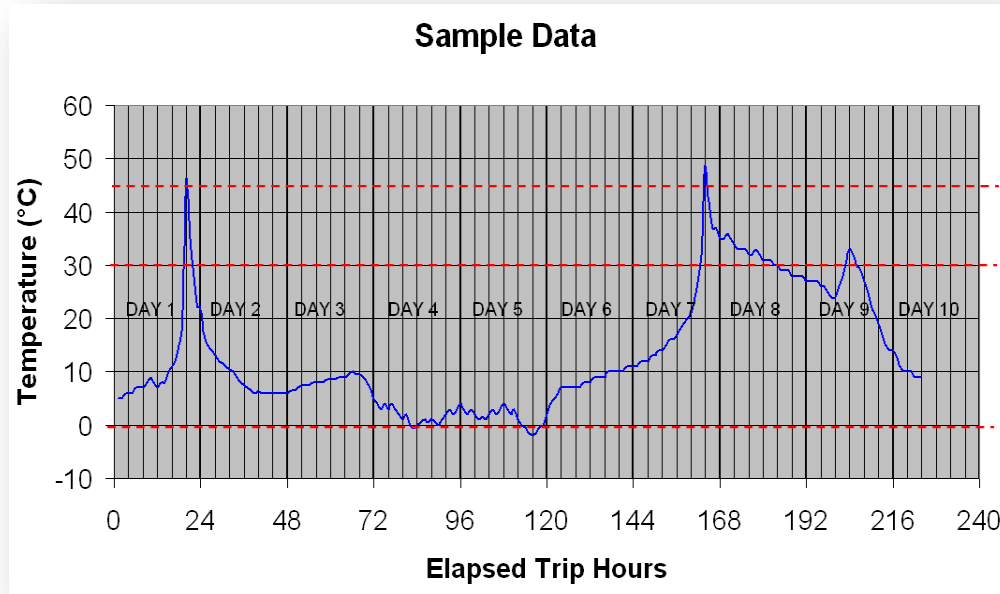

An example data set is used to demonstrate an Indicator with the alarm settings as described above, where monitoring was stopped on day 10.







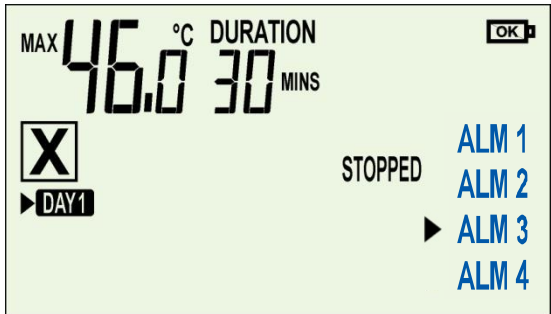



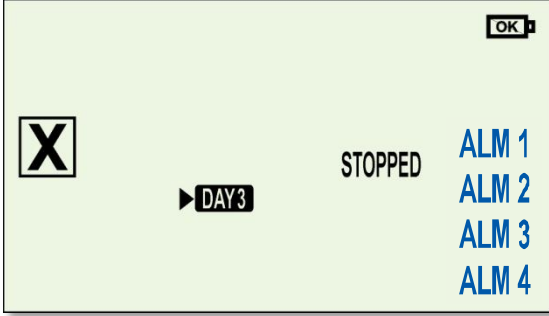

For this example the processing on a day by day basis for ten days is as shown in the table below:-





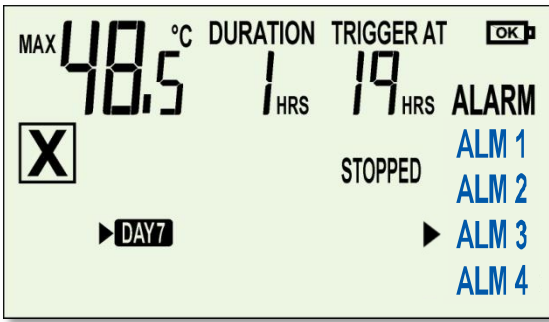

		Carried over	Exposure hrs	Total hrs	Alarm	Trigger-hr	To be carried over	Statistic Displayed
DAY 1	> 45 deg	0	0.5	0.5	no	n/a	0	Max 46°C, 30 min duration
	> 30 deg	0	2	2	no	n/a	2	Max 46°C, 2 hrs duration
	< 0.5deg	0	0	0	no	n/a	10	
DAY 2	> 45 deg	0	0	0	no	n/a	0	
	> 30 deg	2	0	2	no	n/a	2	
	< 0.5deg	0	0	0	no	n/a	18	
DAY 3	> 45 deg	0	0	0	no	n/a	0	
	> 30 deg	2	0	2	no	n/a	2	
	< 0.5deg	0	0	0	no	n/a	0	
DAY 4	> 45 deg	0	0	0	no	n/a	0	
	> 30 deg	2	0	2	no	n/a	2	
	< 0.5deg	0	0.5	.5	no	n/a	0	Min -0.7°C, 30 min duration
DAY 5	> 45 deg	0	0	0	no	n/a	0	
	> 30 deg	2	0	2	no	n/a	2	
	< 0.5deg	0	4	4	yes	18	0	Min -2.0°C, 4 hrs, 18 th hr trigger
DAY 6	> 45 deg	0	0	0	no	n/a	0	
	> 30 deg	2	0	2	no	n/a	2	
	< 0.5deg	0	0	0	no	n/a	0	
DAY 7	> 45 deg	0	1	1	yes (1)	19	0	Max 48.5°C, 6 hrs, 19 th hr trigger
	> 30 deg	2	6	8	no	n/a	8	Max 48.5°C, 6 hrs duration
	< 0.5deg	0	0	0	no	07	17	
DAY 8	> 45 deg	0	0	0	no	n/a	0	
	> 30 deg	8	14	22	yes (2)	2 and 12	2	Max 36°C, 14 hrs, 2 nd hr trigger
	< 0.5deg	0	0	0	no	n/a	0	
DAY 9	> 45 deg	0	0	0	no	n/a	0	
	> 30 deg	2	4.5	6.5	no	n/a	6.5	Max 33°C, 4.5 hrs duration
	< 0.5deg	0	0	0	no	n/a	5	
DAY 10	> 45 deg	0	0	0	no	n/a	END	
	> 30 deg	2	0	2	no	n/a	END	
	< 0.5deg	0	0	0	no	n/a	END	

Review walk-through

Day	Temperature conditions and alarm trigger status	Display
<p>1</p>	<p>Press and release the REVIEW button.</p>  <p>The ► arrow will appear next to DAY1.</p> <p>If temperatures exceeded or fell below any limit, the statistics data and any alarm raised are now displayed.</p> <p>In this instance temperatures above 30°C (indicated by the ► next to ALM2) were recorded for 2 hours, with a maximum of 46.0°C. This did not trigger an alarm, as the alarm trigger requires cumulative exposure of 10 hours or more to temperatures above 30°C.</p> <p>Press and release the REVIEW button to advance to the next screen.</p>  <p>On day 1 temperatures above 45°C were recorded for a time of 30 Minutes, indicated by the ► next to ALM2. Again, this did not trigger an alarm, as only constant exposure for one hour to temperatures above 45°C triggers this alarm.</p>	 
<p>2</p>	<p>Press and release the REVIEW button to advance to the next screen.</p>  <p>Since no further events were recorded for day 1, the screen now shows data for day 2, indicated by the arrow ► next to DAY2.</p> <p>Temperatures remain below 30°C and above -0.5°C during all of day 2, therefore no statistics are being displayed, and no alarms have yet been triggered.</p>	

Day	Temperature conditions and alarm trigger status	Display
<p>3</p>	<p>Press and release the REVIEW button to advance to the next screen.</p>  <p>Since no further events were recorded for day 2, the screen now shows data for day 3, indicated by the arrow ► next to DAY3.</p> <p>Temperatures remain below 30°C and above -0.5°C during all of day 2, therefore no statistics are being displayed, and no alarms have been triggered.</p>	
<p>4</p>	<p>Press and release the REVIEW button to advance to the next screen.</p>  <p>Since no further events were recorded for day 3, the screen now shows data for day 4, indicated by the arrow ► next to DAY4.</p> <p>Temperatures below -0.5°C were recorded for a time of 30 Minutes, indicated by the ► next to ALM1. This did not trigger an alarm, as only constant exposure for one hour to temperatures lower than -0.5°C triggers this alarm.</p>	
<p>5</p>	<p>Press and release the REVIEW button to advance to the next screen.</p>  <p>Since no further events were recorded for day 4, the screen now shows data for day 5, indicated by the arrow ► next to DAY5.</p> <p>Temperatures below -0.5°C were recorded for a total time of 4 hours. This triggered the alarm ALM1, as constant exposure for more than one hour to temperatures lower than -0.5°C was recorded.</p> <p>The first temperature reading below -0.5°C was recorded after 17 hours on day 5, and after 18 hours on that day the alarm condition was met, which is shown as the alarm trigger time.</p>	

Day	Temperature conditions and alarm trigger status	Display
<p>6</p>	<p>Press and release the REVIEW button to advance to the next screen.</p>  <p>Since no further events were recorded for day 5, the screen now shows data for day 6, indicated by the arrow ► next to DAY6.</p> <p>Temperatures remain below 30°C and above 0.5°C during all of day 2, therefore no statistics are being displayed, and no alarms have been triggered.</p>	
<p>7</p>	<p>Press and release the REVIEW button.</p>  <p>Since no further events were recorded for day 6, the screen now shows data for day 7, indicated by the arrow ► next to DAY7.</p> <p>In this instance temperatures above 30°C (indicated by the ► next to ALM 2) were recorded for 6 hours, with a maximum of 48.5°C. This did not trigger an alarm, as the alarm trigger requires cumulative exposure of 10 hours or more to temperatures above 30°C.</p> <p>Press and release the REVIEW button.</p>  <p>Temperatures above 45°C were recorded for a time of 1 hour with a maximum reading of 48.5°C. This triggered a single event alarm at 19 hours, indicated by the ► next to ALM 3.</p>	 

Day	Temperature conditions and alarm trigger status	Display
<p>8</p>	<p>Press and release the REVIEW button.</p>  <p>Since no further events were recorded for day 7, the screen now shows data for day 8, indicated by the arrow ► next to DAY8.</p> <p>Temperatures above 30°C were recorded for 14 hours with a maximum temperature of 36.0°C.</p> <p>The >30°C alarm trigger ALM 2 occurred at hour 2, when the cumulative time for temperature exposure above 30°C reached 10 hours.</p> <p>A second >30°C alarm trigger occurs again at hour 12, but only the 1st alarm statistic is shown.</p>	
<p>9</p>	<p>Press and release the REVIEW button.</p>  <p>Since no further events were recorded for day 8, the screen now shows data for day 9, indicated by the arrow ► next to DAY9.</p> <p>Temperatures above 30°C were recorded for 4.5 hours, with a maximum of 33.0°C. This did not trigger an alarm.</p>	
<p>10</p>	<p>Press and release the REVIEW button.</p>  <p>Since no further events were recorded for day 9, the screen now shows data for day 10, indicated by the arrow ► next to DAY10.</p> <p>Temperatures remain below 30°C and above -0.5°C during day 10, therefore no statistics are being displayed, and no alarms have been triggered.</p> <p>The Indicator was stopped on Day10.</p> <p>Pressing the REVIEW button again will display the statistics for DAY1.</p> <p>Pressing the START STOP button at any time will show the STOPPED display</p>	

TIC20 Factory Pre-sets

LogTag® TIC20 indicators cannot be client configured, but instead are purchased with one of a number of different factory configuration profiles pre-installed. If a default configuration does not suit, customers can compile their own profile by specifying the parameters in the table below when ordering. Please note that minimum order quantities apply for TIC20 units with profiles not stocked by LogTag®.

The default configuration profile is called "Profile 0006"; each custom configuration is assigned a different profile number which can be used for ordering.

Description		Profile 0006 (default)	Range / Option	Requirement
Maximum Days (Maximum number of days to monitor)		20	1-20	
Sampling interval		6 minutes*	1 to 15 minutes	
Start Delay		60 minutes	0 to 99 minutes, 0=no delay	
Display Temperature units		°C	°C or °F **	
Hibernate once STOPPED (Stops the Real Time Clock, increases length of period in which the unit can be downloaded)		off	on or off	
Allow stopping with STOP button		on	on or off	
ALM 1 (Alarm Limit 1)	Monitor this alarm	enabled	enabled or disabled	
	Temperature limit value	10°C	-30°C to 60°C (-22°F to 140°F)	
	Alarm activation	instant	instant, accumulated or consecutive***	
	Activation delay time****	N/A	1 minute to 45 days	
	Direction	upper	upper/lower	
ALM 2 (Alarm Limit 2)	Monitor this alarm	enabled	enabled or disabled	
	Temperature limit value	8°C	-30°C to 60°C (-22°F to 140°F)	
	Alarm activation	accumulated	instant, accumulated or consecutive***	
	Activation delay time****	12 hours	1 minute to 45 days	
	Direction	upper	upper/lower	
ALM 3 (Alarm Limit 3)	Monitor this alarm	enabled	enabled or disabled	
	Temperature limit value	2°C	-30°C to 60°C (-22°F to 140°F)	
	Alarm activation	accumulated	instant, accumulated or consecutive***	
	Activation delay time****	12 hours	1 minute to 45 days	
	Direction	lower	upper/lower	
ALM 4 (Alarm Limit 4)	Monitor this alarm	enabled	enabled or disabled	
	Temperature limit value	0°C	-30°C to 60°C (-22°F to 140°F)	
	Alarm activation	instant	instant, accumulated or consecutive***	
	Activation delay time****	N/A	1 minute to 45 days	
	Direction	lower	upper/lower	

* 6 minutes = 0.1 hour; preferred intervals are 1, 2, 3, 6 and 12 minutes

** When °F is chosen, temperatures above 99°F will be shown on the display without a decimal point, but will be listed correctly in downloaded data.

*** Instant = one temperature reading is above/below limit; consecutive = temperature readings are above/below limit for the time defined in the activation delay time without interruption (single event); accumulative = temperature readings above/below limit for a total of time defined in the Activation delay time, but may not necessarily be sequential.

**** Delay times for alarm activations must be in multiples of the sampling interval.

Product Specifications

LogTag® Part Code	TIC20
Operating Temperature Range	-30°C to +60°C (-22°F to +140°F)
Ambient humidity range during transport and use	0% to 95%RH
Resolution	0.1°C or better in range of -30°C to +60°C 0.2°F from -22°F to 99.8°F, 1°F from 100°F to +140°F
Accuracy	better than ±0.5°C for -10°C to +40°C (+14°F to +104°F) better than ±1.0°C for -30°C to -10°C (-22°F to +14°F) better than ±1.0°C for +40°C to +60°C (+104°F to +140°F)
Capacity	Minimum & maximum temperature for each of the 20 days. 1 st activation of each alarm for each day including trigger time and duration of each excursion. Please note the TICT does not store each individual temperature reading taken.
Memory type	Non-volatile.
Sampling Interval	1-15minutes, factory set to 6 minute interval for profile 0006 (i.e. 0.1hour)
Recordings	20 day statistics, temperature/time excursions and alarm trigger time and duration for each day.
Start delay	1-99 minutes, factory set to 60 minutes for profile 0006
Sensor	Precision electronic thermistor
Sensor Reaction time	T90 less than 7 minutes by method detailed in EN12830:1999
Vibration	Withstands vibration specification as detailed in EN12830:1999
Shock	Withstands shock specification as detailed in EN12830:1999 Withstand 5 drops 1m to smooth concrete floor without loss of function or calibration.
Environmental	IEC 60529: IP64
Resistance to Electrical Storms	Designed to resist the effects of intense electrical storms.
Power source	3V Lithium battery – non replaceable
Battery life	Minimum storage life of 18 months before 'start'. Monitoring period: 20 days. Minimum accessibility (display) period of 6 months after 'stopped'
Size	73mm(H) x 54.5mm(W) x 8.6mm(T) (Volume < 34cm ³)
Weight	30g.
Case Material	Polycarbonate.
Warranty	One year replaceable warranty against defects in materials and workmanship from the date of purchase. Excludes misuse or abuse of the product or as a result of unauthorized alteration or repairs.
Calibration	Certificate of Traceability and Calibration to ISO/IEC17025 available on request.
EMC compliance	EC EMC directives (EN 61000-6-1:2005 & EN 61000-6-3:2006) Including electrostatic discharge as prescribed in EN 61000-4-2. Complies with FCC Part 15 Subparts A and B.
Alarms function & display	Alarms are displayed on a custom LCD. Display is static allowing photocopying.

This product is designed to meet or exceed the WHO PQS performance specification E06/TR07.x