

TEMPERATURE CHAMBERS

(- 40 °C ...+ 180 °C)

Model:

TK-68 CKLT

TK-190 CKLT

TK-340 CKLT

TK-500 CKLT

TK-1000 CKLT

- Material temperature resistance and product testing
- Maintaining superior temperature stability
- Sample conditioning prior to other tests
- Data loggers and sensors calibration
- Temperature controlled test polygon
- World class metrology performance
 - Accelerated ageing
 - Stress tests

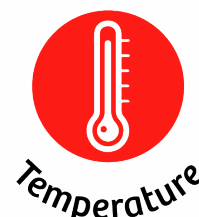

Device description:



Touch display with advanced controller functions:

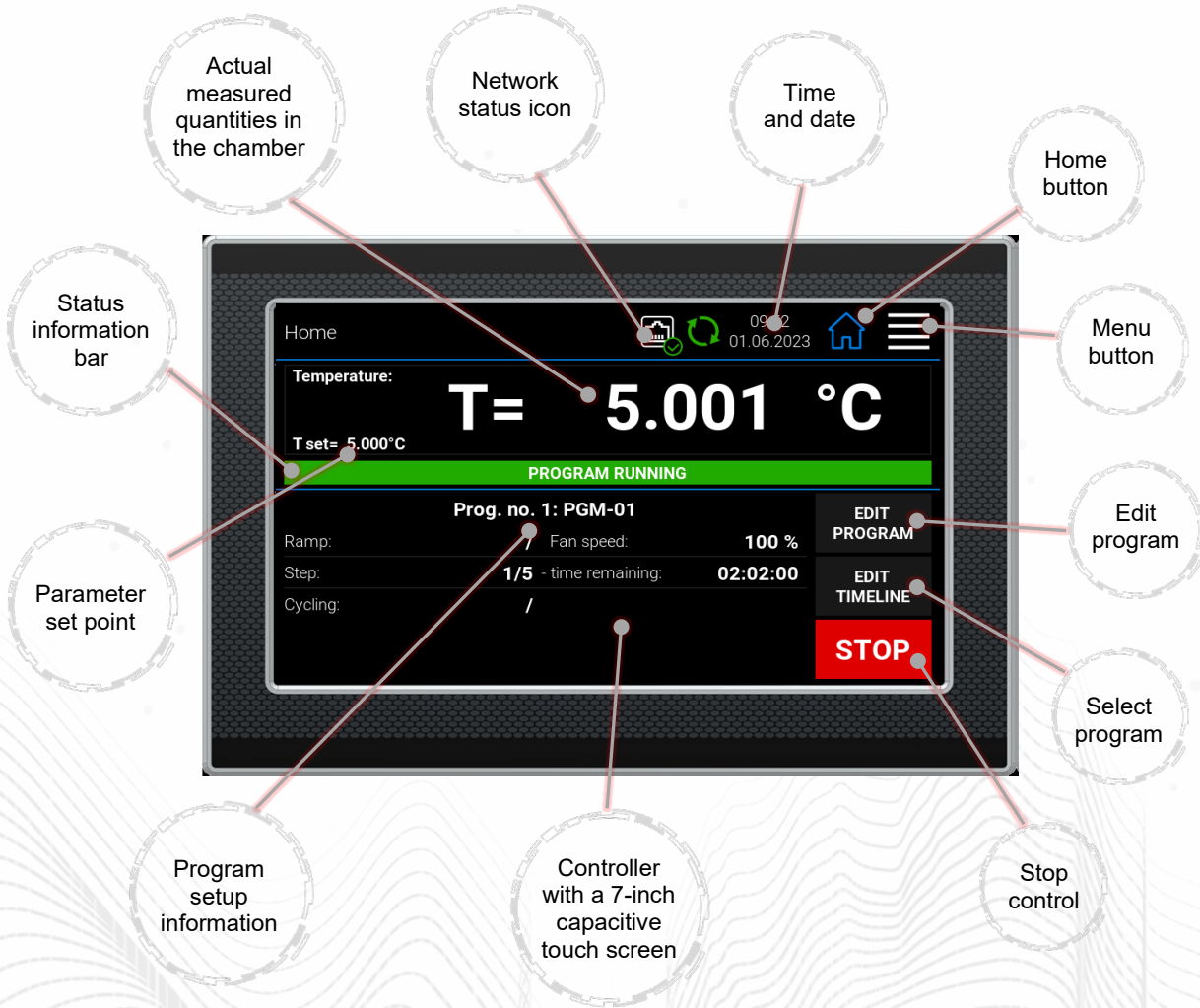

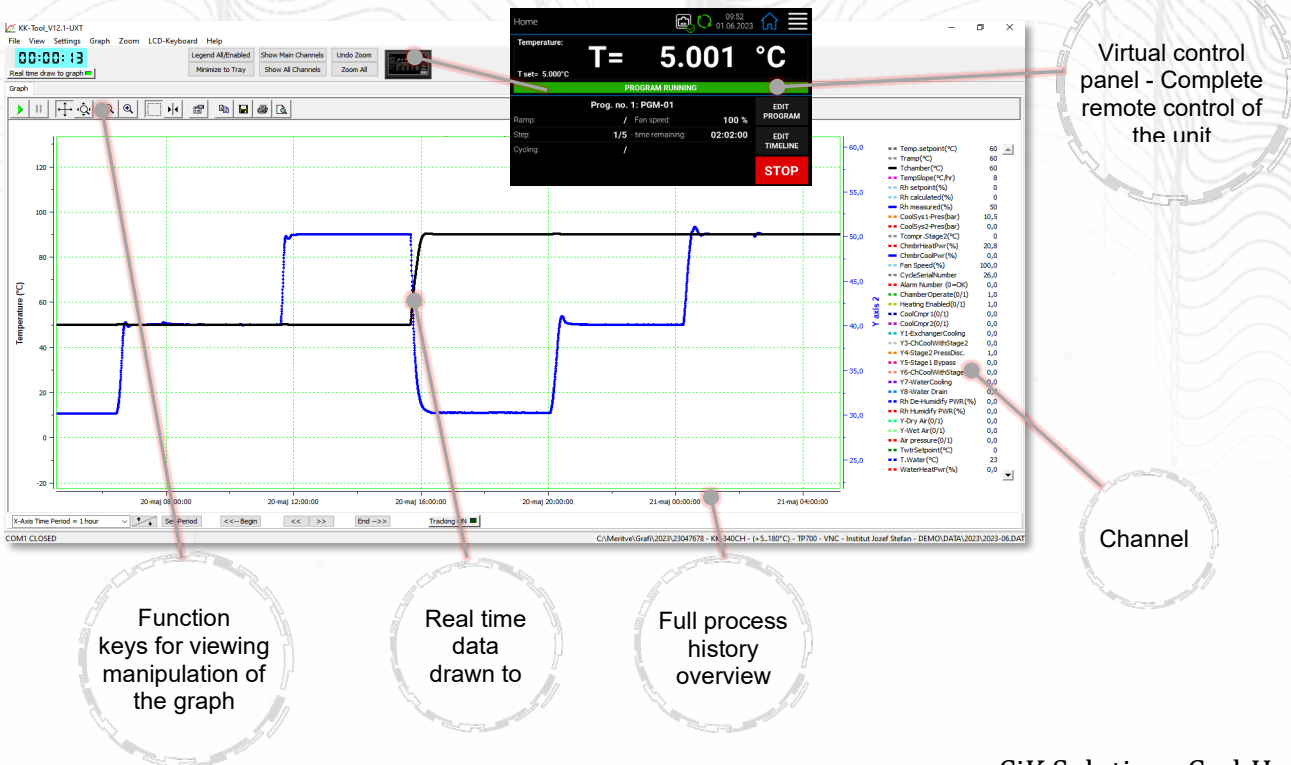

KK-Tool software for PC (free – included with every unit):

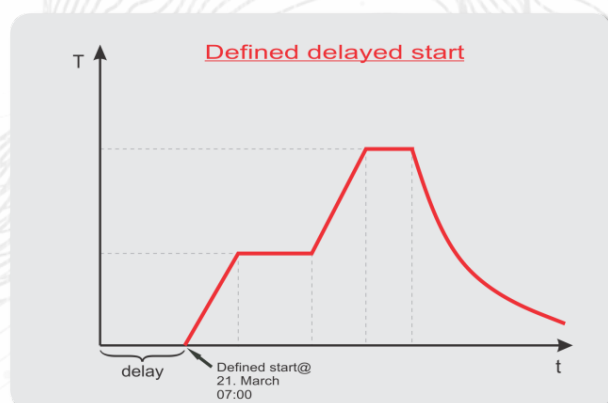
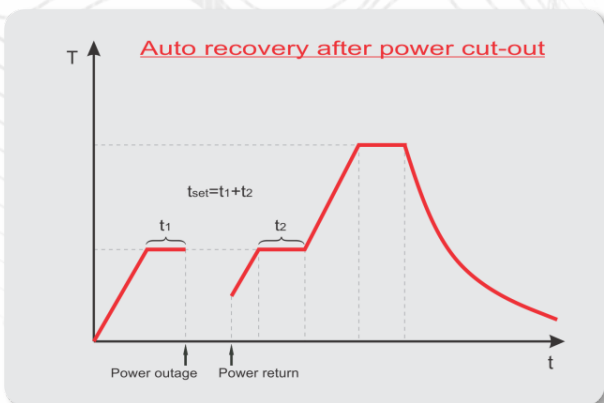
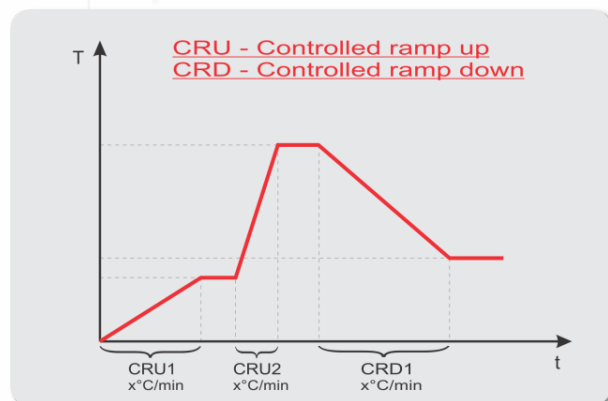
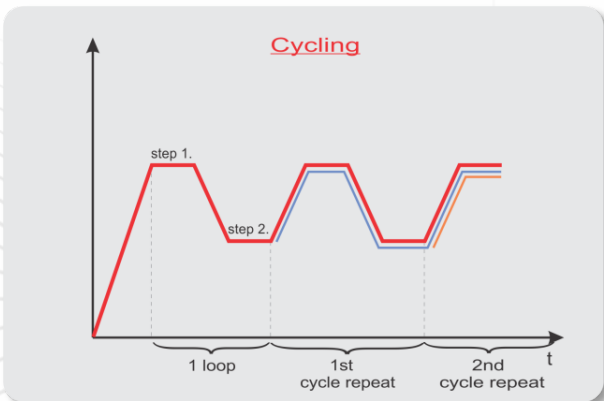
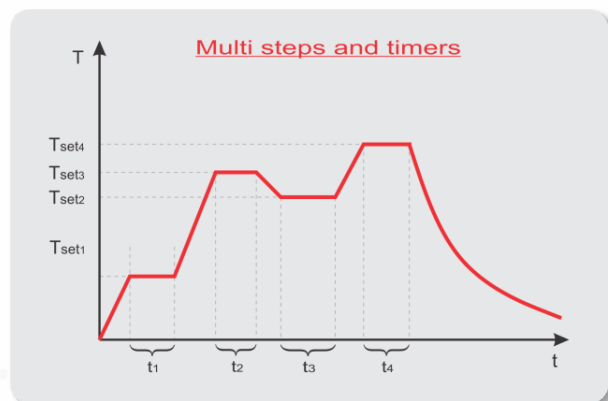
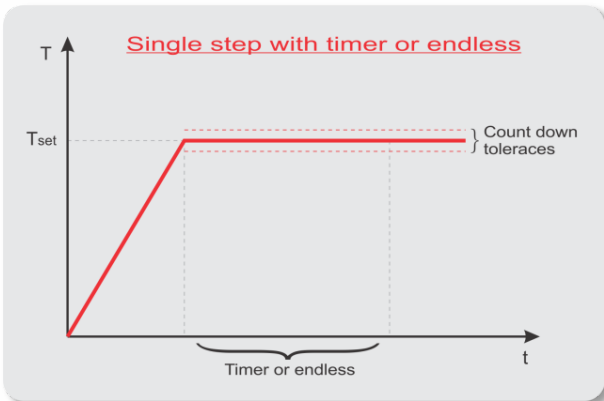

Controller functions:

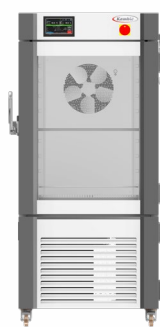

	TK-68 CKLT	TK-190 CKLT	TK-340 CKLT
			
External dimensions (WxHxD) [mm]	650 x 1223 x 796	835 x 1661 x 951	835 x 1881 x 1126
Internal dimensions (WxHxD) [mm]	410 x 475 x 350	600 x 615 x 510	600 x 835 x 685
Volume [L]	~ 68	~ 190	~ 340
Temperature range [°C]	- 40 ...+ 180	- 40 ...+ 180	- 40 ...+ 180
Heat up rate [°C/min] (according to EN 60068-3-5)	4.0	2.0	1.5
Cool down rate [°C/min] (according to EN 60068-3-5)	2.5	3.0	2.5
Temperature display res [°C]	0.1	0.1	0.1
Temperature set res. [°C]	0.1	0.1	0.1
Temperature stability [°C]	± 0.15°C @ - 40°C ± 0.05°C @ 50°C ± 0.05°C @ 90°C ± 0.15°C @ 180°C	± 0.15°C @ - 40°C ± 0.05°C @ 50°C ± 0.05°C @ 90°C ± 0.15°C @ 180°C	± 0.15°C @ - 40°C ± 0.05°C @ 50°C ± 0.05°C @ 90°C ± 0.15°C @ 180°C
Temperature uniformity [°C]	± 0.8°C @ - 40°C ± 0.3°C @ 50°C ± 0.3°C @ 90°C ± 2.0°C @ 180°C	± 0.5°C @ - 40°C ± 0.3°C @ 50°C ± 0.3°C @ 90°C ± 1.5°C @ 180°C	± 0.5°C @ -40°C ± 0.3°C @ 50°C ± 0.3°C @ 90°C ± 1.5°C @ 180°C
Heat compensation [W]	~ 250 @ - 30 °C ~ 750 @ - 10 °C ~ 1500 @ + 20 °C	~ 350 @ - 30 °C ~ 950 @ - 10 °C ~ 3000 @ + 20 °C	~ 350 @ - 30 °C ~ 1150 @ - 10 °C ~ 3000 @ + 20 °C
Temperature control	PID (PT-100)	PID (PT-100)	PID (PT-100)
Power supply	230V 50/60 Hz	230V 50/60 Hz	230V 50/60 Hz
Wattage [W]	2500	3000	3000
Interface	USB and Ethernet	USB and Ethernet	USB and Ethernet
Shelve	1 (max 6)	1 (max 8)	1 (max 8)
Shelve capacity [kg]	25	35	35
Max capacity [kg]	40	80	100
Observation window	As standard	As standard	As standard
Access port [mm]	Ø 50 (left side)	Ø 50 (left side)	Ø 50 (left side)
Noise [dBA] @ 1 m distance	58	60	60
Weight [kg]	190	273	319

*All performance in controlled environment ($T_{ambient} = 22\text{ °C} \pm 3\text{ °C}$)!

*Accessories might affect performance!

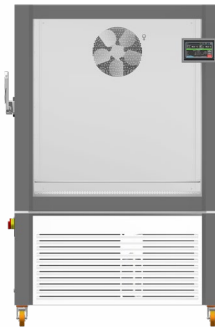
	TK-500 CKLT	TK-1000 CKLT
		
External dimensions (WxHxD) [mm]	1035 x 1880 x 1381	1235 x 1928 x 1579
Internal dimensions (WxHxD) [mm]	800 x 835 x 800	1000 x 1035 x 1000
Volume [L]	~ 500	~ 1000
Temperature range [°C]	- 40 ...+ 180	- 40 ...+ 180
Heat up rate [°C/min] (according to EN 60068-3-5)	3.5	3.3
Cool down rate [°C/min] (according to EN 60068-3-5)	3.0	2.5
Temperature display res [°C]	0.1	0.1
Temperature set res. [°C]	0.1	0.1
Temperature stability [°C]	± 0.15°C @ - 40°C ± 0.05°C @ 50°C ± 0.05°C @ 90°C ± 0.2°C @ 180°C	± 0.15°C @ - 40°C ± 0.05°C @ 50°C ± 0.05°C @ 90°C ± 0.2°C @ 180°C
Temperature uniformity [°C]	± 0.5°C @ - 40°C ± 0.3°C @ 50°C ± 0.3°C @ 90°C ± 1.5°C @ 180°C	± 0.5°C @ - 40°C ± 0.3°C @ 50°C ± 0.3°C @ 90°C ± 1.5°C @ 180°C
Heat compensation [W]	~ 850 @ - 30 °C ~ 2050 @ - 10 °C ~ 3000 @ + 20 °C	~ 500 @ - 30 °C ~ 2000 @ - 10 °C ~ 5000 @ + 20 °C
Temperature control	PID (PT-100)	PID (PT-100)
Power supply	3x400V 50/60Hz	3x400V 50/60Hz
Wattage [W]	7500	8500
Interface	USB and Ethernet	USB and Ethernet
Shelve	1 (max 8)	1 (max 8)
Shelve capacity [kg]	50	50
Max capacity [kg]	150	200
Observation window	As standard	As standard
Access port [mm]	Ø 50 (left side)	Ø 50 (left side)
Noise [dBA] @ 1 m distance	62	62
Weight [kg]	430	599

**All performance in controlled environment ($T_{ambient} = 22\text{ °C} \pm 3\text{ °C}$)!*

**Accessories might affect performance!*

Ordering information and accessories:

Description	Part no.
Climatic chamber TK-68 CKLT	791
Climatic chamber TK-190 CKLT	1048
Climatic chamber TK-340 CKLT	1122
Climatic chamber TK-500 CKLT	3029
Climatic chamber TK-1000 CKLT	3031
Shelve wire TK-68 CKLT	792
Shelve wire TK-190 CKLT	953
Shelve wire TK-340 CKLT	956
Shelve wire TK-500 CKLT	958
Shelve wire TK-1000 CKLT	960
Shelve perforated TK-68 CKLT	793
Shelve perforated TK-190 CKLT	954
Shelve perforated TK-340 CKLT	957
Shelve perforated TK-500 CKLT	959
Shelve perforated TK-1000 CKLT	961
Access Port w. Plug Ø 50 mm right (<i>*specify position</i>)	899
Access Port w. Plug Ø 100 mm right (<i>*specify position</i>)	900
Trolley for TK-68 CKLT	794
Evaluation report 9 points, 3 temperatures - performed by Kambic	1719
Evaluation report 9 points, 3 temperatures- Accredited	2852

**Accessories might affect performance!*

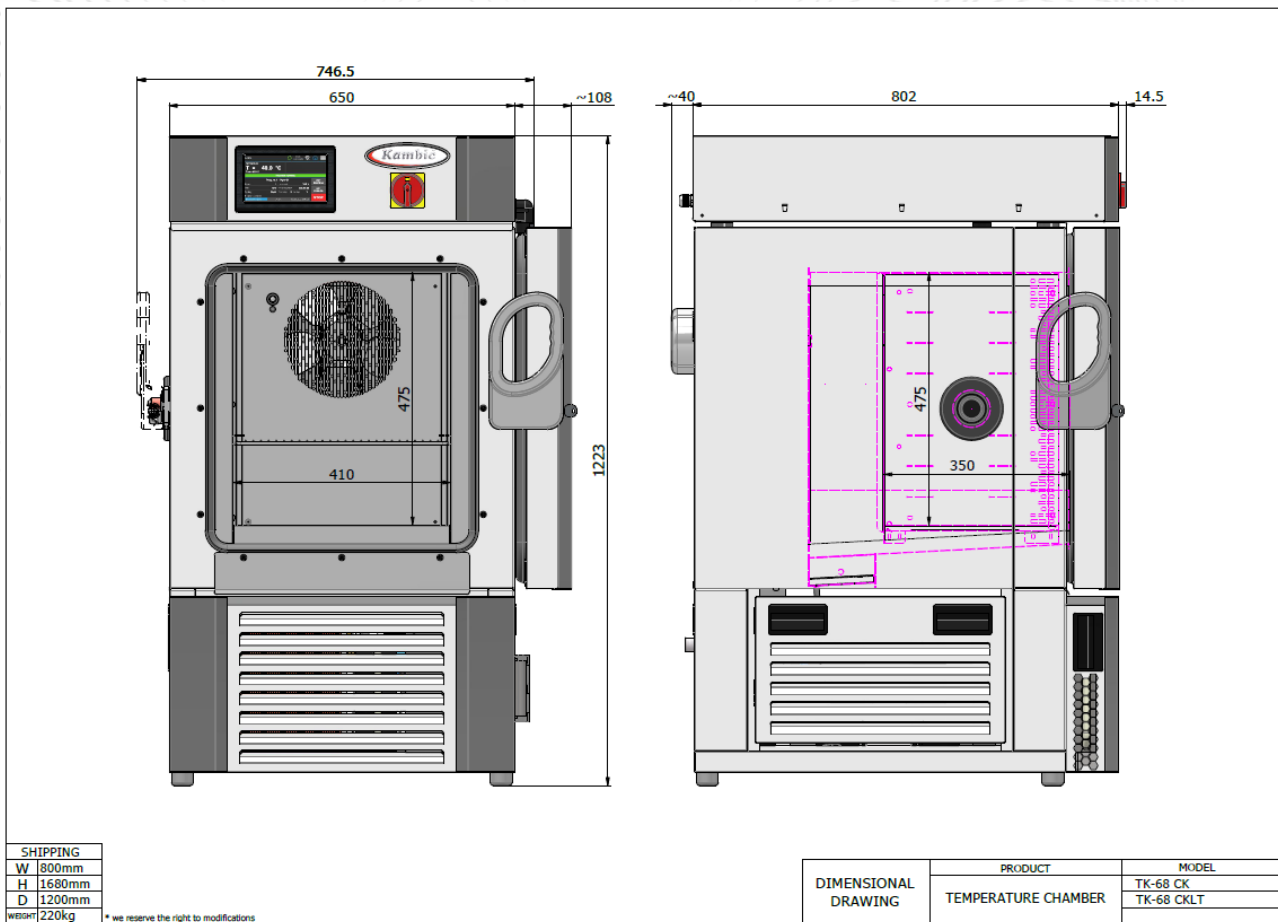

SHIPPING	
W	800mm
H	1680mm
D	1200mm
WEIGHT	220kg

* we reserve the right to modifications

DIMENSIONAL DRAWING	PRODUCT	MODEL
	TEMPERATURE CHAMBER	TK-68 CK TK-68 CKLT

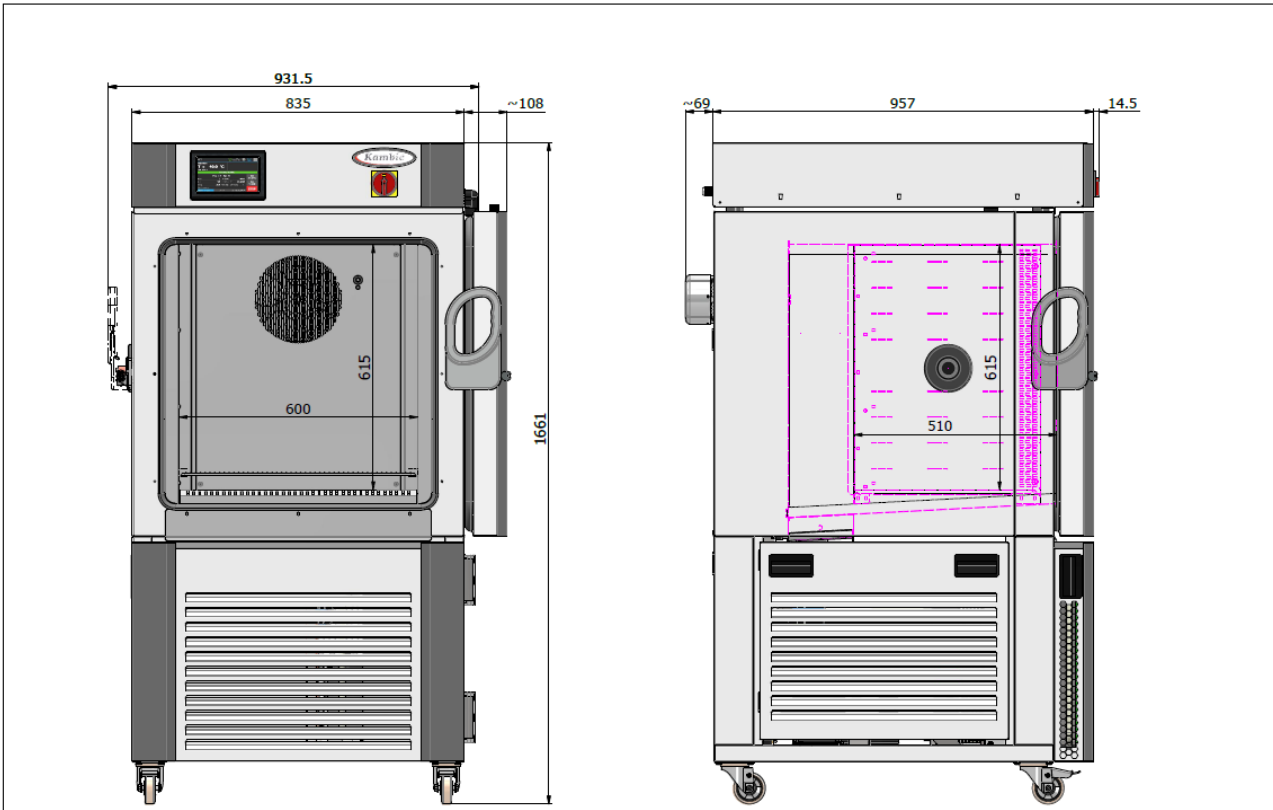

SHIPPING	
W	1100mm
H	1900mm
D	1240mm
Weight	380kg

* we reserve the right to modifications

DIMENSIONAL DRAWING	PRODUCT	MODEL
	TEMPERATURE CHAMBER	TK-190 CK TK-190 CKLT

